

ONYX™ Swing-arm PC Edition

User's Guide

Freedom Scientific Blind/Low Vision Group, LLC
August 2007

Part #440369-001 Revision C

PUBLISHED BY
Freedom Scientific
11800 31st Court North
St. Petersburg, Florida 33716-1805
USA
<http://www.FreedomScientific.com>

Information in this document is subject to change without notice. No part of this publication may be reproduced or transmitted in any form or by any means electronic or mechanical, for any purpose, without the express written permission of Freedom Scientific.

© 2007 Freedom Scientific Blind/Low Vision Group, LLC. All Rights Reserved.

ONYX™ and MAGic® EyeMerge™ are trademarks of Freedom Scientific Blind/Low Vision Group, LLC in the United States and other countries.

Federal Communications Commission Notice

This equipment has been tested and found to comply with the limits for a Class B digital device, pursuant to Part 15 of the FCC Rules. These limits are designed to provide reasonable protection against harmful interference in a residential installation. This equipment generates, uses, and can radiate radio frequency energy and, if not installed and used in accordance with the instructions, may cause harmful interference to radio communications. However, there is no guarantee that interference will not occur in a particular installation. If this equipment does cause harmful interference to radio or television reception, which can be determined by turning the equipment off and on, the user is encouraged to try to correct the interference by one or more of the following measures:

- Increase the separation between the equipment and receiver.
- Connect the equipment into an outlet on a circuit different from that to which the receiver is connected.
- Reorient or relocate the receiving antenna.
- Consult the dealer or an experienced radio or television technician for help.

Note: Unit has been designed for connection to an IT power distribution system.

Do Not Make Modifications to Remote Control

Changes or modifications not expressly approved by the party responsible for compliance could void the user's authority to operate the equipment.

Table of Contents

Overview	1
ONYX Swing-arm PC Edition Components	2
What's in the Box	2
Safety and Maintenance	3
Getting Started	5
Assembling ONYX	5
Camera Assembly.....	5
Video and Power Connections.....	8
Connecting Video Cables	9
Connecting Power Using a Wall Outlet.....	10
Connecting Power Using a Computer's USB Port.....	10
Installing and Starting Magnification Software	11
Turning ONYX Swing-arm PC Edition On.....	13
Positioning Camera for Long Distance or Close-up Work	14
Camera Positions and Settings.....	14
Basic Operation Using the ONYX Remote Control	16
Turning ONYX Swing-arm PC Edition On and Off	16
Changing Magnification	16
Adjusting Brightness	17
Changing Viewing Modes	17
Centering on a Distant Image	18
Flipping an Image	18
Using the Freeze Button	19

Using the Masking Menu	20
Reading Lines – Marker 1 and Marker 2	21
Exiting the Menu	22
Adjusting Enhanced Image Contrast	23
Saving Camera Settings	23
ONYX Remote Control Functions	24
Power/Function LED	25
Mode Button (Blue)	25
Find Button (Gray).....	26
Flip (Light Blue)	26
Zoom Buttons (Black)	27
Brightness Buttons (Yellow)	27
Freeze and Focus Lock Button (Orange).....	28
Menu Button (Brown)	29
Power Button (Green)	31
Service and Support	32
Troubleshooting	33
General Information – ONYX Models	40

The ONYX™ Camera makes seeing printed type, pictures, handwriting, and small details easier than ever before.

The ONYX includes the following features:

- Document reading
- Distance reading
- Self viewing
- Auto Focus creates the clearest view without any need to make adjustments.
- Adjust pre-set video modes for high contrast text that is most comfortable for your individual eyesight.
- Increase or decrease brightness
- Masking
- Reading Lines
- Freeze frame
- Find function to easily target distant objects

ONYX Swing-arm PC Edition Components

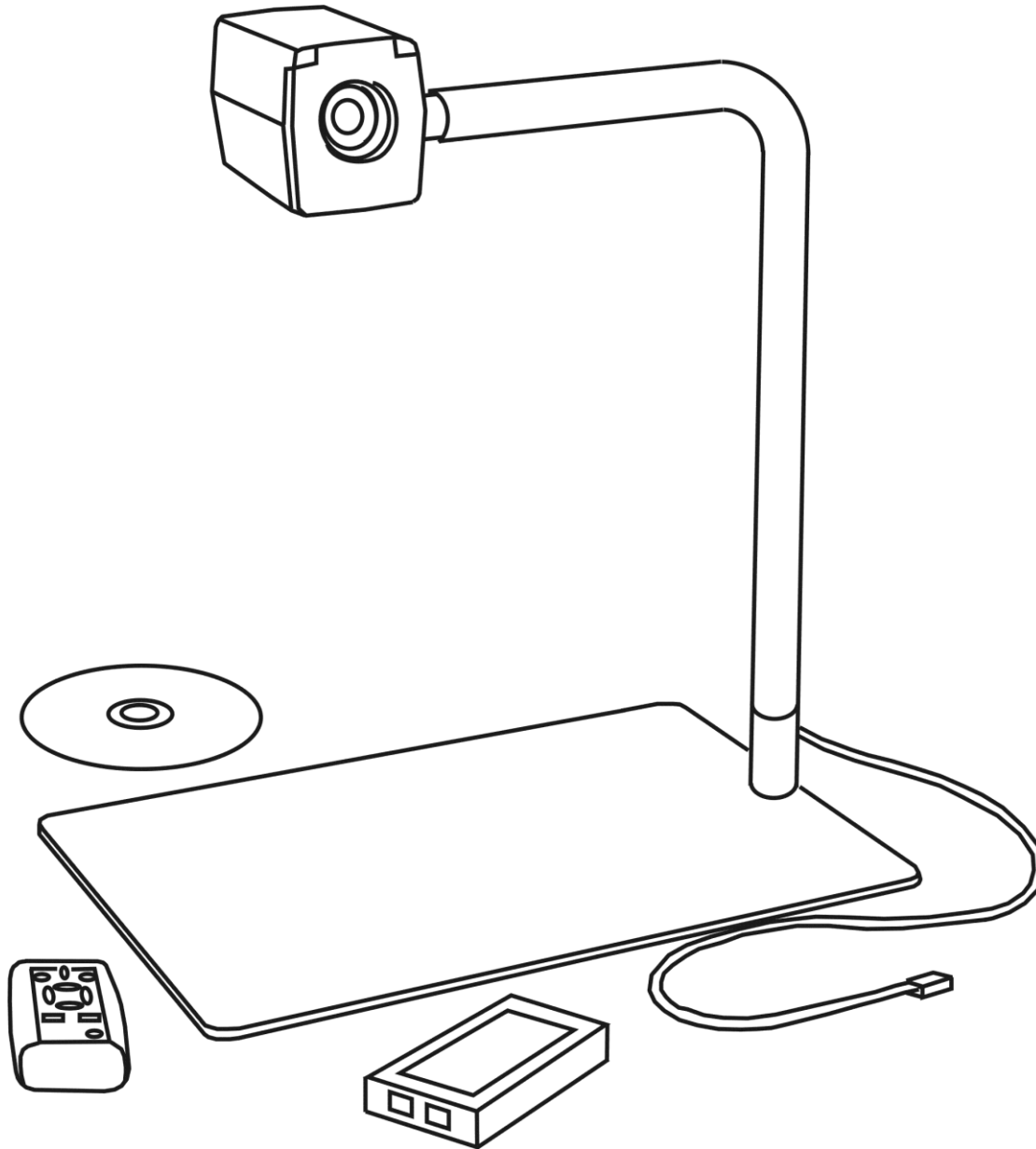

What's in the Box

- ONYX vision camera
- Base plate
- Swinging camera arm
- ONYX USB interconnect box
- Remote control with two AAA batteries
- Power cable and universal 110-240V AC adapter
- Power-to-USB cable
- USB cable
- MAGic® software CD
- ONYX user's guide

Safety and Maintenance

To keep the unit in good condition and to ensure safe usage, observe the following guidelines:

- Read the instructions in this user's guide before attempting to use the unit.
- Do not attempt to repair the unit or open its case. This product contains no user serviceable parts.
- Do not attempt to modify the remote control. Changes or modifications not expressly approved by the party responsible for compliance could void the user's authority to operate the equipment.
- Keep the unit away from wet areas, rain, and other sources of liquids or high humidity. Do not submerge the unit.
- Always operate the unit in a place where the temperature is between 10° and 40° C (50° and 104° F).
- Always store the unit in a place where the temperature is between -20° and 65° C (-4° and 149° F). Do not store in a parked car, because the temperature often exceeds this range.
- Always use the unit on a stable, level, hard surface such as a desk or table.
- Never force connectors into the unit's ports. All appropriate connectors should fit easily into the ports. If the connector does not fit, turn it around, and try again.

- Use only the power cable that came with your unit. Other adapters may damage the unit.
- When cleaning the unit, use a clean, soft cloth. Do not spray or pour any liquid on the unit.

Assembling ONYX

Before beginning the assembly, place the ONYX components on a sturdy and stable work surface, such as a desk or table. Assembly is straightforward and will be very familiar to you after setting it up for use and breaking it down for travel.

Camera Assembly

1. Place the base plate flat on the table and place the camera arm on to the base plate pin. Make sure to seat it completely down over the pin.
2. Attach the camera to the camera arm connector.

Note: The camera and camera arm connector have a tongue and groove design. Make sure that the top groove on the camera's connector fits snugly over the top of the camera arm connector as shown in the following figure.

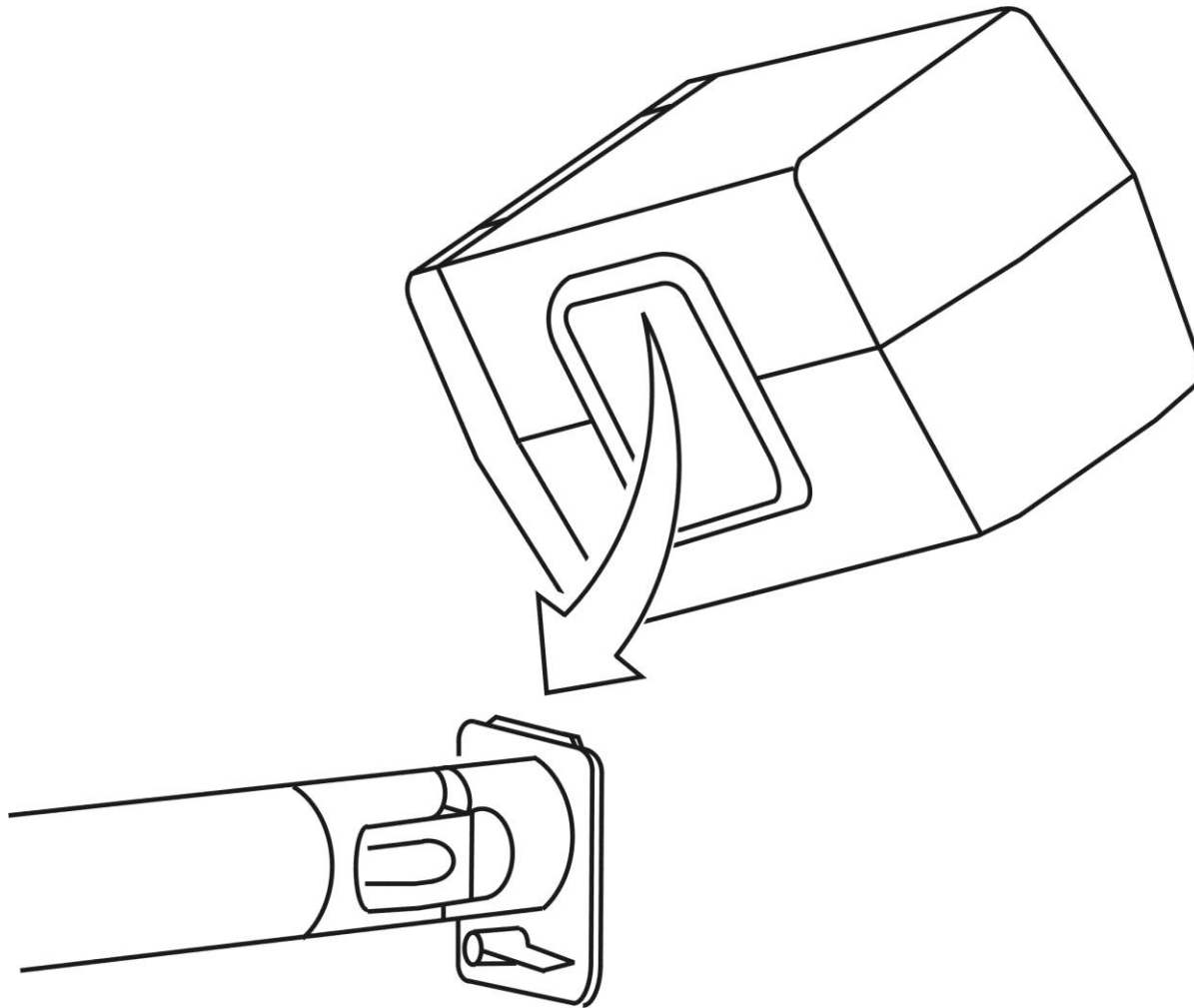

Attaching the ONYX camera to the camera arm connector.

3. Rotate the locking lever down to lock the camera in place.

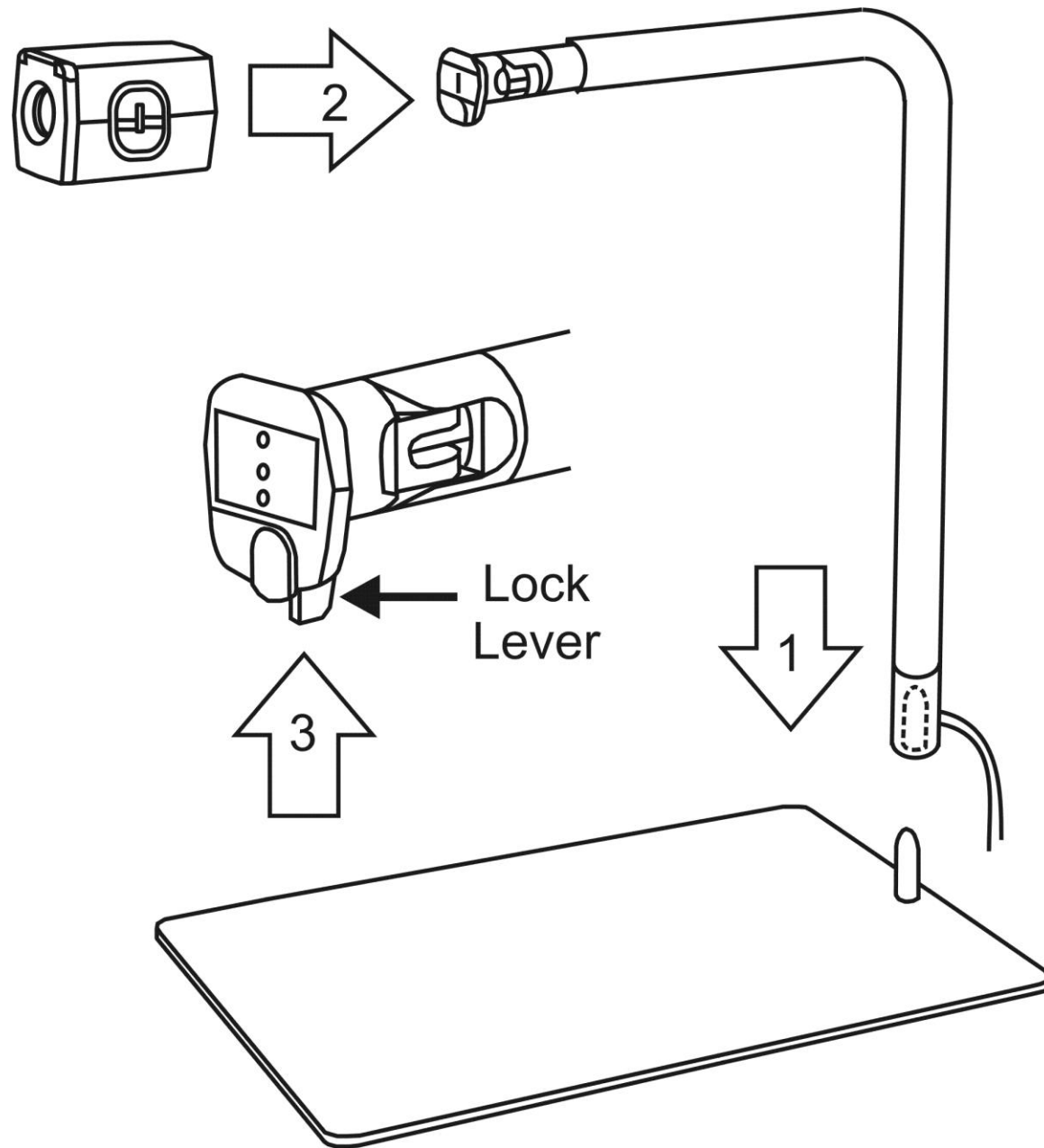

ONYX Swing-arm PC Edition camera assembly.

Video and Power Connections

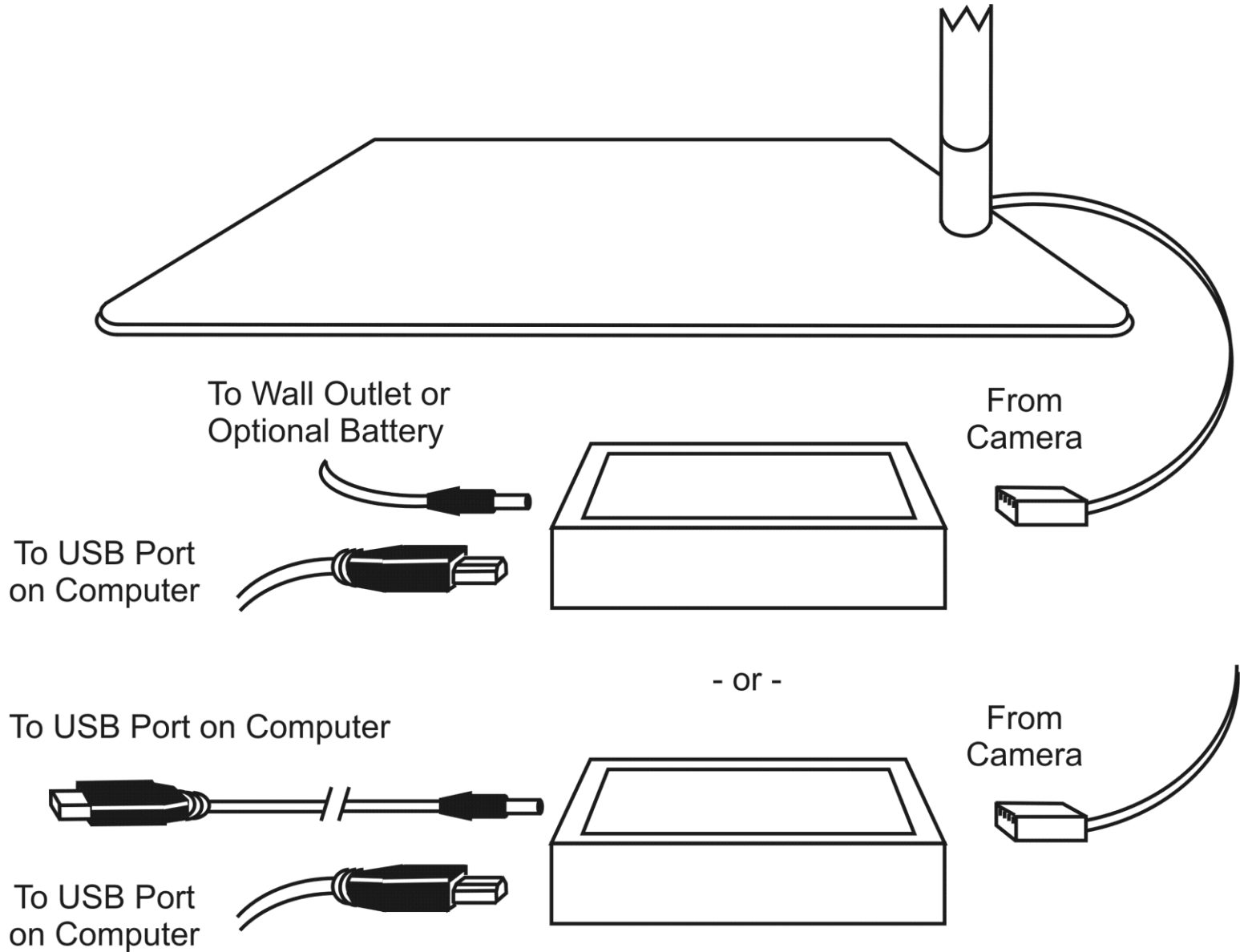

ONYX Swing-arm PC Edition video and power connections.

Connecting Video Cables

1. Plug the camera's modular RJ45 connector into the keyed RJ45 connector on the USB interconnect box.

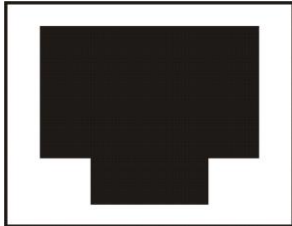

RJ45 connector on USB interconnect box.

A click sound is made when the modular connector snaps into place.

2. Insert the USB cable's Type B plug into the USB receptacle on the USB interconnect box.

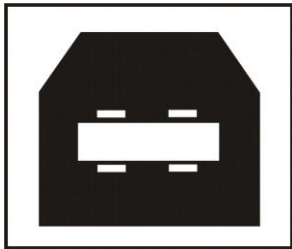

Type B USB receptacle on USB interconnect box.

3. Insert the USB cable's Type A plug into a USB receptacle on your computer.

Connecting Power Using a Wall Outlet

1. Plug the power connector into the receptacle labeled DC In on the USB interconnect box.

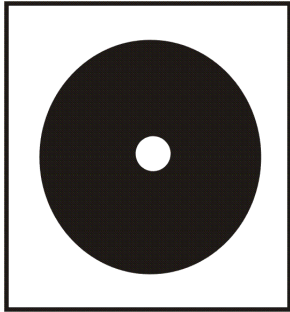

Power receptacle on USB interconnect box.

2. Plug the power cord into a wall outlet. The ONYX Swing-arm PC Edition derives power from the AC wall outlet.

Connecting Power Using a Computer's USB Port

Note: Use the supplied Power-to-USB (Type A) cable to draw power from your computer.

1. Plug the power connector on the Power-to-USB cable into the receptacle labeled DC In on the USB interconnect box.
2. Plug the other end of the Power-to-USB cable into a USB port on your computer. The ONYX Swing-arm PC Edition derives power from your computer.

Installing and Starting Magnification Software

A magnification program, MAGic EyeMerge™, is available for you to control ONYX. It is included on your MAGic application CD.

Note: To run the MAGic EyeMerge application, your computer must have a video card that supports Microsoft DirectX® 9.0.

To install MAGic EyeMerge, do the following:

1. Insert the MAGic CD into your CD-ROM drive.
2. When the **MAGic Setup** dialog box appears, choose the **MAGic Setup** button.

Tip: If your MAGic installation CD does not start automatically, click the **Start** button, select **Run**, and type **D:\setup**. If your CD-ROM is not D, substitute the correct drive letter.

3. The MAGic Setup program starts. You will hear the installation speak the instructions as they appear on your screen. Follow these instructions to complete the MAGic installation.

Note: If you are installing MAGic EyeMerge on a Windows Vista computer, the following message may appear.

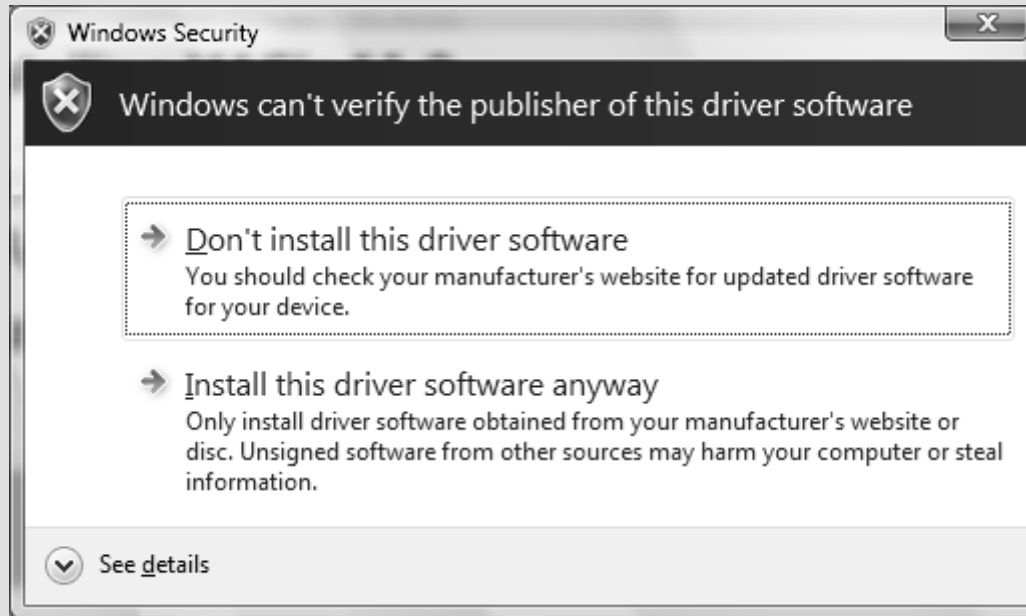

Choose **Install this driver software anyway.**

4. To start the application, choose the Windows **Start** button, choose **Programs**, open the **MAGic EyeMerge XX** submenu, where XX is the version number, and choose **MAGic EyeMerge**. Refer to the application's help system for general operation procedures.

Turning ONYX Swing-arm PC Edition On

1. Verify that the magnification software is installed and running.
2. Insert two AAA batteries into the remote control.
3. Press the green **POWER** button , which is located in the lower right corner of the remote control. There is no need to aim the remote control at the camera. When the camera is on, a red LED on the bottom of the camera is lit.
4. If an image does not appear on your computer, verify that the computer is on.

Positioning Camera for Long Distance or Close-up Work

For long distance reading, keep the camera lens up.

For close-up reading or self viewing, keep the camera lens down.

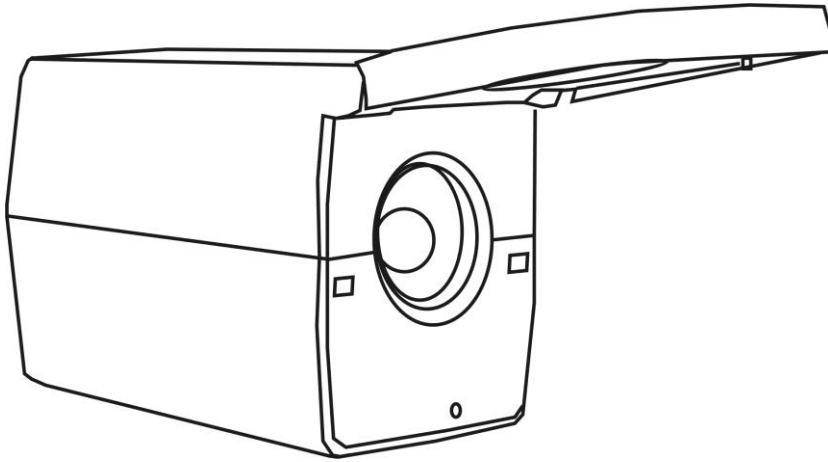

Distance reading configuration.

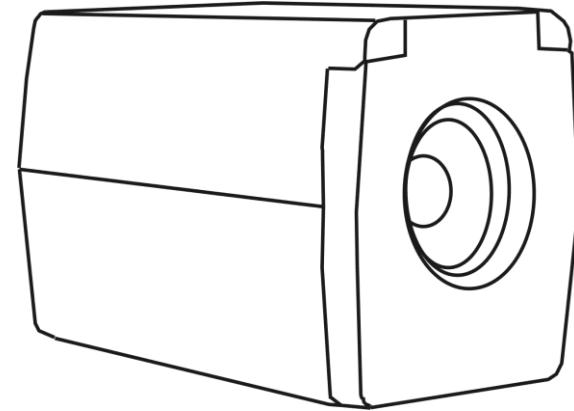

Desktop and self-view configuration.

Camera Positions and Settings

There are four primary camera positions:

- Horizontal with lens up – for looking at distant objects
- Horizontal with lens down – for looking at nearby objects
- Vertical and facing down – for when the camera is rotated to look down at an object on the base plate or desktop

- Horizontal and upside down with lens down – for when the camera is rotated and pointed at yourself for self viewing

When the camera is placed into each of these different positions, it recalls the brightness, magnification, viewing mode, mask, Reading Lines, and other essential settings that you created for that specific position. This allows you to make a separate camera configuration for distance viewing, in which the magnification and brightness are adapted for that situation, while also having a separate configuration for desktop viewing, one that takes magnification, viewing mode, and brightness into account when reading a book.

Important:

Any changes made to the camera while it is in a given position are automatically saved and used the next time you move the camera to that position. To permanently save these settings, you must power the ONYX off using the POWER button on the remote control.

Basic Operation Using the ONYX Remote Control



Turning ONYX Swing-arm PC Edition On and Off

1. Connect all cables as previously described in the Video and Power Connections section on page 8.
2. Turn on the computer and launch the magnification software.



3. Press the green **POWER** button  on the remote control. The red LED on the bottom of the camera turns on.

4. Press the green **POWER** button  again to turn the ONYX Swing-arm PC Edition off.

Changing Magnification

- Press the black **PLUS** button , which is located in the center of the remote control, to zoom-in and enlarge the object that appears on the screen.
- Press the black **MINUS** button , also located in the center of the remote control, to zoom away from the object on the screen.

Adjusting Brightness

- To make the image lighter, press the **RIGHT ARROW** button , which is located in the center of the remote control.
- To make the image darker, press the **LEFT ARROW** button , which is located in the center of the remote control.

Changing Viewing Modes

- Press the blue **MODE** button, located in the upper left corner of the remote control, to cycle through the following viewing modes:
 - Color
 - Inverted Color
 - Black and White Positive
 - White and Black Negative

Centering on a Distant Image

To locate the center of the image that appears on the screen, do the following:

1. Press and hold the gray **FIND** button, which is located in the upper center section of the remote control.

The camera zooms out and crosshairs temporarily appear on the screen indicating the center of the image on the screen.

2. Center the crosshairs on the object you wish to view, and release the gray **FIND** button to zoom in.

Flipping an Image

With the ONYX vision camera, you can change the screen orientation so that the image is flipped and mirrored both horizontally and vertically. (Note that the camera is configured so that it will flip to a mirror image when rotated into the self-viewing position.)



This function is useful when the object you are viewing is upside down. For example, if you receive a heavy package, it may be easier to flip the image around instead of turning over the package.

- Press the light blue **FLIP** button, located in the upper right corner of the remote control, four times to cycle through the four different picture orientations.

Note: The camera will remember this setting the next time you rotate it back to this position.

Using the Freeze Button

The **FREEZE** button has two primary functions. The first is to freeze the current image that appears on the screen. This is useful when viewing distant images such as text on a blackboard. The second is to turn on or off Auto Focus. This is useful when working or writing under the camera.

1. Press the orange **FREEZE** button , which is located on the lower left side of the remote control, once to freeze the current image that appears on the screen. The Menu text FREEZE appears in the lower left corner of the screen.
2. Press the **FREEZE** button  again to turn Auto Focus off. The image unfreezes and the Menu text LOCK appears in the lower left corner of the screen.
3. Press the **FREEZE**  button a third time to return to the camera's standard Auto Focus live view.

Using the Masking Menu

Note: The remote control's Masking functionality is disabled when the ONYX camera is connected to the supplied USB interconnect box. To mask a document or image, you must use the MAGic EyeMerge software and the following keystrokes: **F12+K** to enable screen markers and **F12+Y** to select masking. Refer to the MAGic EyeMerge help file for more information about masking procedures.



The following procedure applies if the ONYX camera is connected to the video interconnect box. This box is not supplied with the ONYX Swing-arm PC Edition.

Masking blocks the upper and lower halves of the screen, making it easier for you to focus on a specific area of the screen and reducing glare.

1. To turn on masking, press the brown **MENU** button, which is located on the lower right side of the remote control.

The word MASK appears on the screen.

2. To adjust the mask, do one of the following:

- Press the black **MINUS** button  to narrow the mask.
- Press the black **PLUS** button  to widen the mask.

3. To toggle the mask on and off, press the blue **MODE** button.
4. Press the brown **MENU** button to exit the menu.

Reading Lines – Marker 1 and Marker 2

Note: The remote control's Reading Line functionality is disabled when the ONYX camera is connected to the supplied USB interconnect box. To add Reading Lines to a document or image, you must use the MAGic EyeMerge software and the following keystrokes: **F12+K** to enable screen markers and **F12+Y** to select Reading Lines. Refer to the MAGic EyeMerge help file for more information about Reading Line procedures.

The following procedures apply if the ONYX camera is connected to the video interconnect box. This box is not supplied with the ONYX Swing-arm PC Edition.

Reading Lines are used to help you maintain your place while reading text. The ONYX is capable of showing two different Reading Lines known as Marker 1 and Marker 2.

To turn on a single Reading Line, do the following:

1. Press the brown **MENU** button, which is located on the lower right side of the remote control.

2. Press the yellow **RIGHT ARROW** button  until **MARKER 1** appears.
3. Press the blue **MODE** button. The Reading Line appears.

To turn on the second Reading Line, do the following:

1. Press the yellow **RIGHT ARROW** button  until **MARKER 2** appears.

2. Press the blue **MODE** button. The second Reading Line appears.

To move a Reading Line, do the following:

1. Press the brown **MENU** button, which is located on the lower right side of the remote control.

2. Press the yellow **RIGHT ARROW** button  until **MARKER 1** or **MARKER 2** appears.

3. Press the black **PLUS** button  to move the selected Reading Line up.

4. Press the black **MINUS** button  to move the selected Reading Line down.

To turn off a Reading Line, do the following:



- While in Menu mode, with **MARKER 1** or **MARKER 2** appearing on the screen, press the blue **MODE** button, which is located in the upper left corner of the remote control.

Exiting the Menu

To clear Menu text from the screen, do the following:

- Press the brown **MENU** button, which is located on the lower right side of the remote control.

Adjusting Enhanced Image Contrast

1. Press the blue **MODE** button until the Enhanced Positive or Enhanced Negative image appears.
2. Press the brown **MENU** button.
3. Press the yellow **RIGHT ARROW** button  until the word **CONTRAST** appears.
4. Press the black **PLUS** button  to increase contrast.
5. Press the black **MINUS** button  to decrease contrast.

Saving Camera Settings

- To save camera settings, turn ONYX off using the green **POWER** button , which is located in the lower right corner of the remote control.

Note: Camera settings are unique to the camera's position. For example, if Reading Lines are used while reading a document in the desktop position, they may not appear when the camera is rotated and aimed at a blackboard or yourself.

If you unplug ONYX from the wall outlet without turning it off first, any recently configured camera settings are discarded. To save camera settings, always use the **POWER** button to turn off the ONYX. For more information about camera settings, see Camera Positions and Settings on page 14.

ONYX Remote Control Functions

The following diagram illustrates the various controls located on the front of the ONYX remote control. These controls allow you to change how the magnified image displays on the screen. Each control on the camera module is described.

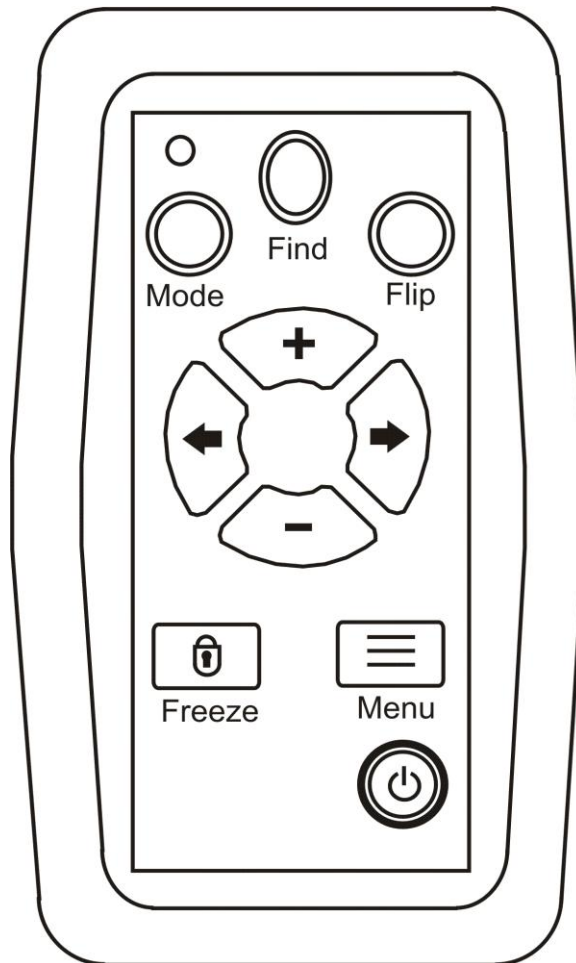





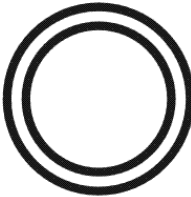

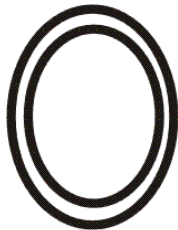
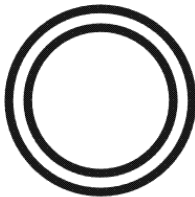
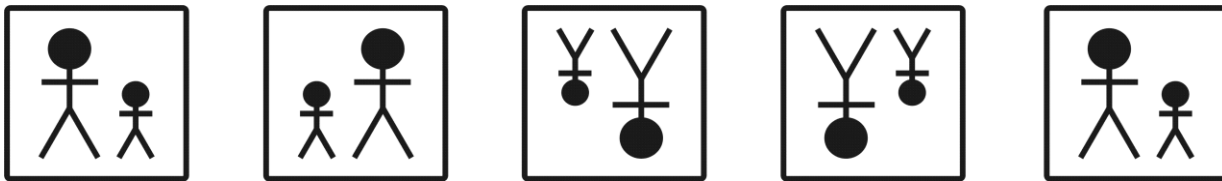

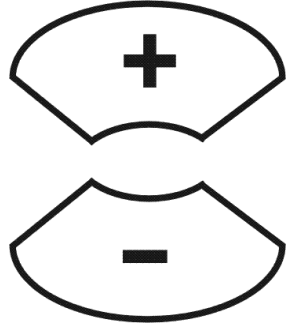
ONYX remote control.

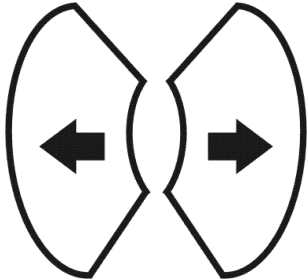
This device complies with Part 15 of the FCC Rules. Operation is subject to the following two conditions: (1) this device may not cause harmful interference, and (2) this device must accept any interference received, including interference that may cause undesired operation.

Button/LED	Description and Function
	<p>Power/Function LED</p> <p>This LED flashes red each time you press a button on the remote control. It is located in the upper left corner of the remote control.</p>
 <p>Mode</p>	<p>Mode Button (Blue)</p> <p>Press the blue MODE button, which is located in the upper left corner of the remote control, to cycle through the following color modes:</p> <ul style="list-style-type: none"> ■ Normal color ■ Reverse color ■ Enhanced Positive (black on white) ■ Enhanced Negative (white on black) <p>Note: When the MODE button is used in conjunction with the brown MENU button, it turns the selected feature on or off.</p>



Button/LED	Description and Function
 <p data-bbox="348 591 485 651">Find</p>	<p data-bbox="611 245 1079 302">Find Button (Gray)</p> <p data-bbox="657 337 1850 623">Press the gray FIND button to locate the center of the object that is currently in view and focus. This is indicated by the crosshairs that temporarily appear on screen. The longer you hold the button, the farther back the camera zooms out to give you a sense of reference. It also helps you determine where the camera is pointing.</p> <p data-bbox="657 662 1829 748">This button is located in the upper center section of the remote control.</p>
 <p data-bbox="352 1149 470 1214">Flip</p>	<p data-bbox="611 797 1016 854">Flip (Light Blue)</p> <p data-bbox="657 889 1860 980">Pressing the light blue FLIP button four times cycles the camera through four different picture orientations.</p> <div data-bbox="657 1013 1871 1192">  </div> <p data-bbox="695 1219 806 1252">Normal</p> <p data-bbox="940 1219 1073 1252">Press 1x</p> <p data-bbox="1199 1219 1331 1252">Press 2x</p> <p data-bbox="1457 1219 1589 1252">Press 3x</p> <p data-bbox="1715 1219 1848 1252">Press 4x</p> <p data-bbox="657 1284 1780 1370">This button is located in the upper right corner of the remote control.</p>

Button/LED	Description and Function
	<p>Zoom Buttons (Black)</p> <p>Press the black PLUS button  to zoom-in and enlarge the object that appears on the screen.</p> <p>Press the black MINUS button  to zoom away from the object on the screen.</p> <p>These buttons are located in the center of the remote control.</p>
	<p>Brightness Buttons (Yellow)</p> <p>Press the yellow RIGHT ARROW button  to increase the brightness level.</p> <p>Press the yellow LEFT ARROW button  to decrease the brightness level.</p> <div style="border: 2px solid black; padding: 5px; margin-top: 10px;"> <p>Note: When used with the brown MENU button, the yellow RIGHT ARROW or LEFT ARROW buttons cycle through the MENU options. Once an option is selected, press the blue MODE button to enable or disable that function.</p> </div>

Button/LED	Description and Function
 <p data-bbox="254 898 432 946">Freeze</p>	<h3 data-bbox="611 245 1623 302">Freeze and Focus Lock Button (Orange)</h3> <p data-bbox="655 367 1780 553">Press the orange FREEZE button  once to freeze the current image that appears on the screen. The Menu text FREEZE appears on the screen. While in Freeze mode, the zoom and brightness features are disabled.</p> <p data-bbox="655 630 1845 1011">Press the FREEZE button  again to turn Auto Focus off. When Auto Focus is on, the camera automatically focuses on the object closest to the camera. When Auto Focus is off, as indicated by the on-screen message, LOCK, the camera does not adjust its focus. Turning Auto Focus off makes it easier to write or work with an object, because the camera will not automatically focus on your hand. During normal operation, it is recommended that you leave Auto Focus on.</p> <div data-bbox="611 1052 1881 1170" style="border: 2px solid black; background-color: #e0e0e0; padding: 5px;"> <p>Tip: When you press this button, the message LOCK appears on the screen when Auto Focus is off.</p> </div> <p data-bbox="655 1243 1782 1333">Press the FREEZE button  a third time to return to the standard Auto Focus camera view.</p> <p data-bbox="655 1373 1824 1463">The orange FREEZE button is located on the lower left side of the remote control.</p>

Button/LED	Description and Function
<div data-bbox="317 743 506 865" data-label="Image"> </div> <p data-bbox="352 878 491 927">Menu</p>	<p data-bbox="611 245 1157 302">Menu Button (Brown)</p> <div data-bbox="611 337 1881 850" data-label="Text" style="border: 2px solid black; padding: 10px;"> <p data-bbox="625 354 1814 493">Note: The remote control's masking and marker functionality is disabled when the ONYX camera is connected to the supplied USB interconnect box.</p> <p data-bbox="751 548 1860 834">To add a mask or Reading Lines to a document or image, you must use the MAGic EyeMerge software and the following keystrokes: F12+K to enable screen markers and F12+Y to toggle between masking and Reading Lines. Refer to the MAGic EyeMerge help file for more information.</p> </div> <p data-bbox="659 889 1831 932">Use the brown MENU button to access the following functions:</p> <ul data-bbox="659 980 1831 1263" style="list-style-type: none"> <li data-bbox="659 980 1831 1127">■ Mask: Covers the upper and lower parts of the screen so that you can concentrate on specific items or lines of text that appear on the screen. <li data-bbox="659 1175 1831 1263">■ Marker 1: Shows a guide line to help guide you and maintain your place while reading text. <p data-bbox="659 1305 1587 1347">See next page for more Menu button information.</p>

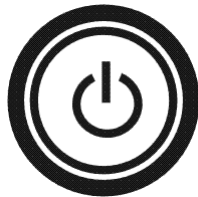
Button/LED	Description and Function
	<p data-bbox="659 245 1514 302">Menu Button (Brown) – continued</p> <ul data-bbox="659 350 1850 727" style="list-style-type: none"> <li data-bbox="659 350 1850 537">■ Marker 2: Shows a line that helps you maintain your place while reading text. When used together with Marker 1, you can create a miniature mask to help isolate a specific area on the screen. <li data-bbox="659 586 1850 727">■ Contrast: (Only available in Enhanced Positive and Enhanced Negative modes.) Adjusts the contrast between light and dark areas of the video image. <div data-bbox="611 768 1879 935" style="border: 1px solid black; padding: 5px;"> <p data-bbox="625 781 1745 922">Note: You can cycle through the menu options by using the yellow RIGHT ARROW or LEFT ARROW buttons in conjunction with the MENU button.</p> </div> <div data-bbox="611 976 1879 1097" style="border: 1px solid black; padding: 5px;"> <p data-bbox="625 989 1860 1078">Note: When in the MENU, the blue MODE button, can be used to enable or disable the selected menu item.</p> </div> <div data-bbox="611 1138 1879 1305" style="border: 1px solid black; padding: 5px;"> <p data-bbox="625 1151 1829 1284">Note: Finally, when you press and hold the brown MENU button for five seconds, you can configure the language for the Menu text.</p> </div> <p data-bbox="659 1341 1860 1430">The brown MENU button is located on the lower right side of the remote control.</p>

Button/LED	Description and Function
 A black power button icon consisting of a circle with a vertical line and a semi-circle inside, surrounded by two concentric circles.	<p>Power Button (Green)</p> <p>Press the green POWER button  to turn the power on for the video source and camera. To turn the power off, press and hold the green POWER button . The red LED on the camera indicates that it is on.</p> <p>The green POWER button is located in the lower right corner of the remote control.</p>

Service and Support

You can contact Freedom Scientific Technical Support to receive technical assistance with ONYX. Before contacting Technical Support, it is recommended that you refer to *Troubleshooting* on page 33 to try to resolve your problem quickly.

If you cannot resolve your issue, you can visit www.FreedomScientific.com. Choose the **Support** link to search the Knowledge Base. The Knowledge Base contains articles that address many common questions and technical issues concerning Freedom Scientific products.



Note: This device has no user-serviceable components. Any unauthorized attempt to service or replace internal components will void the product warranty.

To contact Freedom Scientific Technical Support by telephone, customers in the United States can call (727) 803-8600, Monday through Friday, from 8:30 A.M. to 7:00 P.M. (Eastern Time). Alternatively, you can receive support by e-mail. Send your questions and problems to Support@FreedomScientific.com.





When you call, have your documentation ready and be prepared to provide the following information:

- Product name
- What you were doing when the problem occurred
- How you tried to solve the problem



Troubleshooting

Problem	Solution
<p>The screen is blank.</p>	<p>Ensure that the computer is powered on and that the Power LED for the camera is on. The red Power LED is located on the bottom of the camera.</p> <p>Check that all cables are correctly connected.</p> <p>Check that the magnification software is installed and running.</p> <p>Reduce the magnification level using the black MINUS button .</p> <p>Try adjusting brightness using the yellow BRIGHTNESS buttons  or .</p> <p>Press the blue MODE button to switch to a different video mode.</p>

Problem	Solution
<p>The unit does not turn on.</p>	<p>Ensure that the camera and computer are both plugged in.</p> <p>Ensure that the wall outlets have power and are not malfunctioning. If the outlets are connected to a wall switch, make sure that the switch is on.</p> <p>If you are trying to power ONYX using two USB ports, it is possible your computer does not output enough power through the USB ports. Try connecting power to the wall outlet.</p> <p>Ensure that the remote control is working. The red LED located in the upper left corner of the remote control flashes when a button is pushed. If this does not happen, replace the two AAA batteries.</p>

Problem	Solution
<p>The image on the screen is too bright, or there is a glare from the screen that makes it difficult to see.</p>	<p>Use the yellow BRIGHTNESS buttons  or  to reduce the brightness.</p> <p>Press the blue MODE button to switch to a different video mode.</p>
<p>The image on the screen is too dark.</p>	<p>Use the yellow BRIGHTNESS buttons  or  to increase the brightness.</p> <p>Press the blue MODE button to switch to a different video mode.</p>

Problem	Solution
<p>The image on the screen is blurry or unfocused.</p>	<p>Lift the camera lens and let the camera try to regain focus.</p> <p>Ensure that Auto Focus is on. You can press the orange FREEZE button  to turn Auto Focus on or off.</p> <p>Move the object to within 15 inches of the camera with the lens down or at least 30 inches away from the camera with the lens up.</p> <p>Make sure that the lens is clean.</p> <p>Check that there are no objects in the foreground. The camera might be trying to focus on that object.</p>
<p>The image is upside down.</p>	<p>Use the light blue FLIP button to invert the image.</p>
<p>There are smudges or blemishes on the screen.</p>	<p>Clean the screen using a clean, soft, lint-free cloth. Do not spray or pour any liquid on the screen.</p>

Problem	Solution
Text is too small to read.	Use the black PLUS button  to increase the magnification level.
Text is too large.	Use the black MINUS button  to decrease the magnification level.
When I move the camera to a new position, I lose the previous position's settings.	This is normal operation since camera settings are saved and stored per position. For example, if you have Reading Lines turned on for distant viewing, and then change to desktop viewing or self viewing, the Reading Lines will not appear unless you set them for those camera positions.

Problem	Solution
<p>Note: The following only applies if you are using the optional video interconnect box that allows for connection to a television or DVD player.</p> <p>ONYX is connected to a television, but no magnified image appears on the television screen.</p>	<p>Ensure that the television is plugged into the wall outlet.</p> <p>Ensure that the television is on and set to AUX or VIDEO channel.</p> <p>Ensure that the television cable is securely connected to the ONYX video box.</p> <p>Ensure that the television connector cable is securely connected to the appropriate video input jack on the television.</p>
<p>Note: The following only applies if you are using the optional video interconnect box that allows for connection to a television or DVD player.</p> <p>ONYX is connected to a DVD player, but no magnified image appears on the screen</p>	<p>Make sure the DVD player is set to the correct video source.</p>

Problem	Solution
<p>Masking and Reading Lines do not appear when I press the brown MENU button.</p>	<p>The remote control's masking and marker functionality is disabled when the ONYX camera is connected to the supplied USB interconnect box.</p> <p>To add a mask or Reading Lines to a document or image, you must use the MAGic EyeMerge software and the following keystrokes: F12+K to enable screen markers and F12+Y to toggle between masking and Reading Lines.</p> <p>Refer to the MAGic EyeMerge help file for more information.</p>

General Information – ONYX Models

The ONYX is available in several different models:

The ONYX Flexible-arm includes:

- A magnifying camera
- An articulating arm to orient the camera in a wide range of positions
(You must supply your own television to see magnified images.)

The ONYX Flexible-arm PC Edition includes:

- A magnifying camera
- An articulating arm to orient the camera in a wide range of positions
(You must supply your own television to see magnified images.)
- Cables for USB connectivity to your computer
- MAGic® screen magnification software with image management features to work with your magnified camera image and magnified desktop at the same time.

The ONYX Swing-arm includes:

- A magnifying camera
- A portable arm and stand for quick set-up when moving from room to room
(You must supply your own television to see magnified images.)

The ONYX Swing-arm PC Edition includes:

- A magnifying camera
- A portable arm and stand for quick set-up when moving from room to room
- Cables for USB connectivity to your computer
- MAGic screen magnification software with image management features to work with your magnified camera image and magnified desktop at the same time.

The ONYX Deskset 17 includes:

- A magnifying camera
- A portable arm and stand for quick set-up when moving from room to room
- A 17-inch flat-panel monitor